



# PrimaVision Xtreme for SON

## PV Xt Q 70W SON

Highly reliable electronic drivers for SON lamps designed for saving energy via better light efficiency compared to magnetic drivers and for saving on maintenance costs thanks to a lifetime of up to 80000 hours and the integrated Lightning protection.

### Product data

General Information	
Remarks	UK importer address: Signify Commercial UK Limited, 3, Guildford Business Park, GU2 8XG
Lamp type	SON
Number of lamps	1 piece/unit
Suitable for outdoor use	Yes
Number of products on MCB (16 A type B) (nom.)	11
Default lamp selected	SON70
Automatic restart	Yes
Operating and Electrical	
Input Voltage	208-240-277 V
Input frequency	50 to 60 Hz
Minimum mains voltage operation (min.)	172 V
Operating frequency (nom.)	0.40 kHz
Power factor 100% load (nom.)	0.98
Ignition voltage (max.)	5 kV
Ignition switch-off time (nom.)	20 min
Mains voltage performance (AC)	188-305V
Mains voltage safety (AC)	160-305V

Earth leakage current (max.)	0.7 mA
Output peak voltage (max.)	250 V
Inrush current width	0.24 ms
Lamp power tolerance	-3%/+3%
Input current (nom.)	0.39 A
Inrush current peak (max.)	28 A
Efficiency at full load [%]	89.17 %

### Wiring

Cable capacity output wires mutual (nom.)	1000 pF
Cable length from device to lamp	10 m
Wire strip length	10.0-11.0 mm
Ballast contact wire cross section	0.50-2.50 mm <sup>2</sup>
Connector type	WAGO series 804

### System characteristics

Rated ballast-lamp power	70 W
Rated lamp power on Son	70 W
System power on Son	78 W
Lamp power on Son	70 W
Power loss on Son	8 W

# PrimaVision Xtreme for SON

Power loss on Son while dimming	5 W
---------------------------------	-----

## Temperature

T-ambient (max.)	55 °C
T-ambient (min.)	-30 °C
T storage (max.)	55 °C
T storage (min.)	-30 °C
T-case lifetime (nom.)	80 °C
T-case switch off (min.)	92 °C

## Controls and Dimming

Programmable lamp settings	None
Pre-set integrated controls	None
Programmable dimming options	None
Control input protection	Yes (Basic insulation)
Regulating level	-

## Mechanical and Housing

Housing	Q
---------	---

## Approval and Application

Surge protection (common/differential)	EN61547 (L-L 2kV, L-G 4kV), 10kV TIL kV
IP luminaire classification	34
Active temperature protection	Yes
EMI 9 kHz ... 300 MHz	CISPR 15 ed 7.2
EMI 30 MHz ... 1,000 MHz	CISPR15 Edition 7.2

Safety standard	IEC 607, 609, 926, 928 [ No Standard for HID Lamp drivers exists. Requirements in these standards to be used if considered relevant for the product.]
Quality standard	ISO 9000:2000
Environmental standard	ISO 14001
Harmonic current emission standard	IEC 61000-3-2
Vibration standard	IEC 68-2-6 Fc (10-150Hz, 2G)
Bumps standard	IEC 68-2-29 Eb (10G/16ms)
Humidity standard	EN 61347-2-12 clause 11
Approval marks	F-Marking CE marking ENEC certificate VDE-EMV certificate
Humming and noise level	< 30 dB(A)

## Product Data

Full product code	871829169878400
Order product name	PV Xt Q 70W SON
EAN/UPC – product	8718291698784
Order code	69878400
Local order code	PVXT70SONQ
SAP numerator – quantity per pack	1
Numerator – packs per outer box	12
SAP material	913700690566
SAP net weight (piece)	0.820 kg

## Dimensional drawing

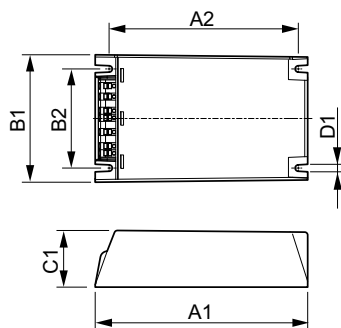

HID-PV Xt 70 SON Q 208-277V

Product	D1	C1	A1	A2	B1	B2
PV Xt Q 70W SON	4.5 mm	40.0 mm	150.0 mm	133.6 mm	90.0 mm	70.0 mm

## PrimaVision Xtreme for SON

